

Beli

Vine Tying Tool

patented

Beli



Operating instructions

Minor rectification

Care and maintenance

GB

Dear customer,

We are pleased that you have chosen the **Beli Vine Tying Tool** and hope that it will serve you well for a long time to come.

To get the best from the tool, it is necessary to familiarize yourself with it.

Place the tying tool in front of you as shown on the right.

Note that the binder wire tip is shown in the picture pointing to the left but that in your new tool it points to the right.

We have done this deliberately to rule out any mistakes before first using the tool.

Leave the wire in this position for the time being.

Now take the tool in your hand and close it. You will now see that the shaft with the ratchet rotates one-sixth of a turn and the return stop engages.

This occurs on each opening and closing.

This brings one of the three wire catchers or one of the three shearing blades into use in sequence.

Now arrange the end of the wire so that it is approximately 1 cm towards the left in the direction of the press-in device, as shown in the top right illustration.

The tool is now ready for use.

Now read the Operating Instruction on pages 2 and 3!

SEIBERT Gerätebau GmbH
Mühlstrasse 19 · D-76889 Barbelroth
Tel. 00 49 (0) 63 43/21 39 or 6 14 54 · Fax 50 94
Internet: www.rebenbindegeraet.de
e-mail: info@rebenbindegeraet.de

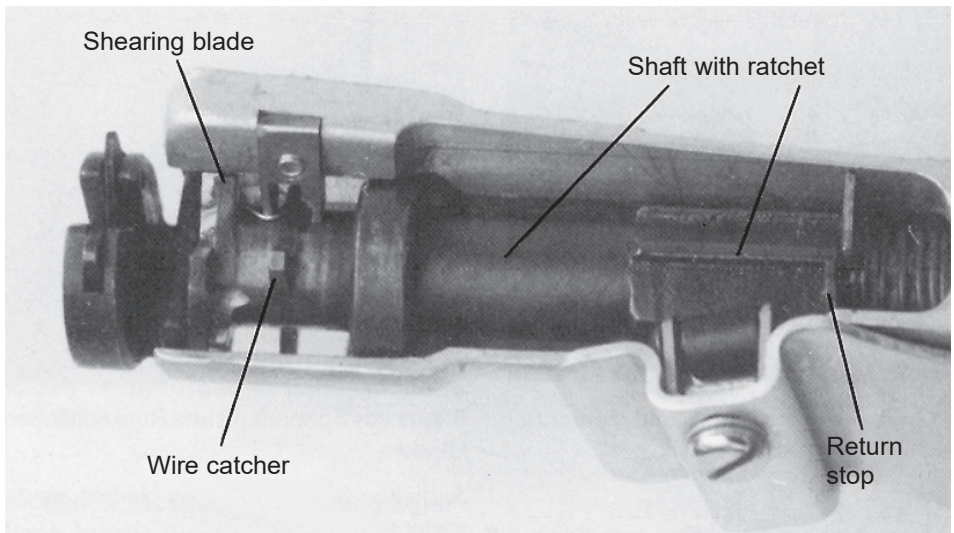
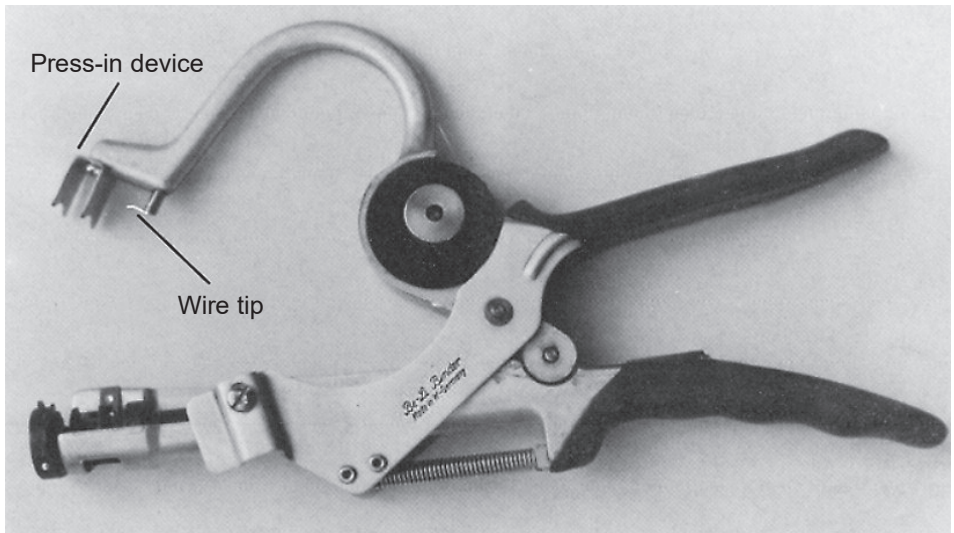

Operating Instructions – sequence

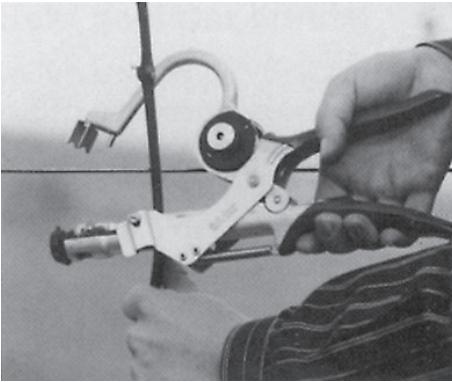

1. Pass the tool in the **open** position **widely** over the tie wire and vine ...

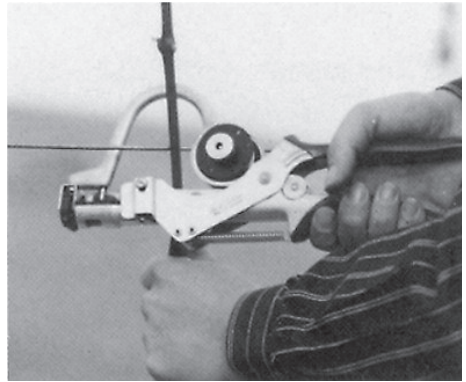

2. ... **without using too much force** close the tool until the wire is clamped in the aperture.

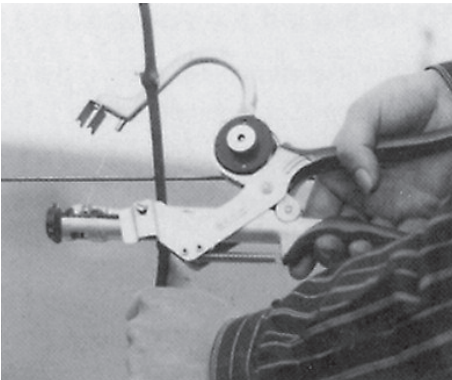

3. **Open** the tool again and withdraw it so that ...

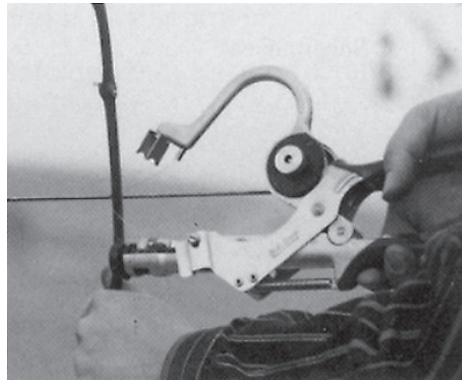

4. ... it can be closed just in front of the tie wire and vine.

The closer to the vine the tighter the tie.

Operating Instructions – sequence



5. Close the **tool without using too** much force until a slight click is heard. The loop is now clamped around the head and the wire cut.

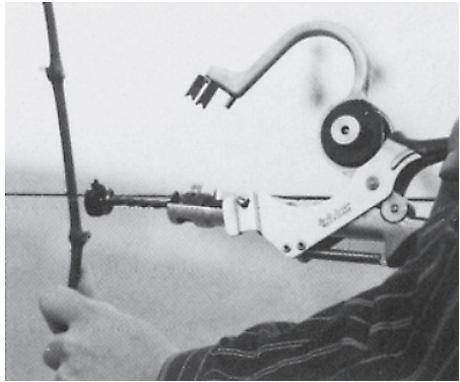

6. Open the tool again and lift it off whilst still **open** until the wire loop is pulled out of the head.

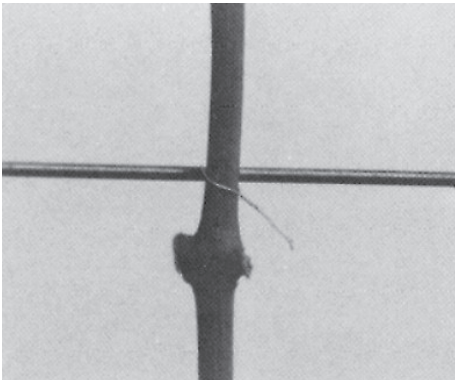

Example of a tight binding

Take it slowly and carefully to begin with!

After a little familiarization you will then be able to work confidently and quickly.

Fitting a new reel

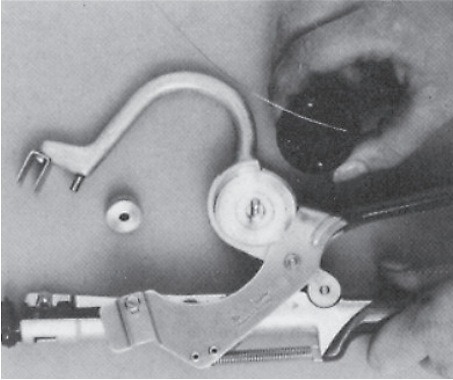

1. Slacken knurled nut and remove old reel.

Insert new reel with the **three knobs downwards**.

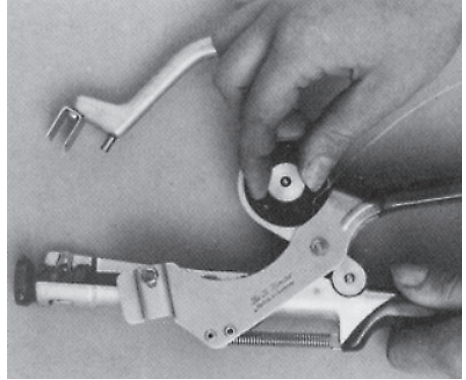

2. Push in knurled nut and then tighten until the reel is **lightly braked**.

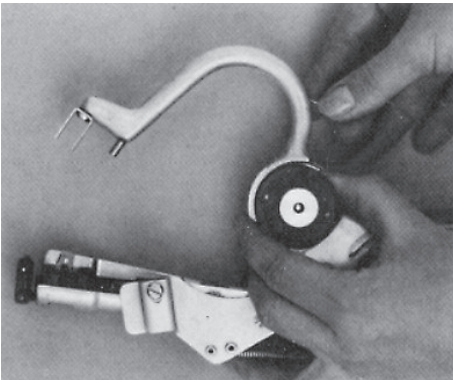

3. Pull out approximately 15 cm of wire and thread it through the wire guide and nozzle.

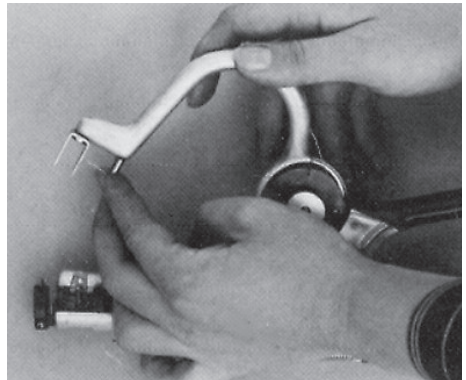

4. Bend approximately 1 cm of the end of the wire upwards in the direction of the press-in device.

Adjusting the reel brake

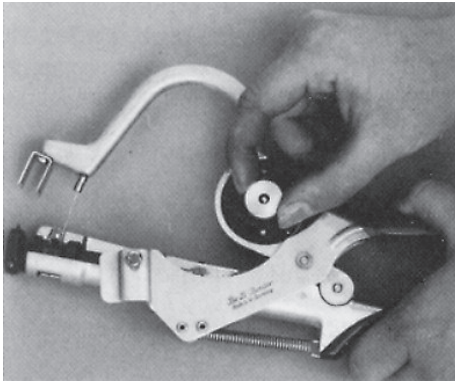

5. Close the tool until the wire is held.
Turn the knurled nut counter-clockwise to slacken the reel brake until the tool opens on its own.

The wire reel must not unroll.

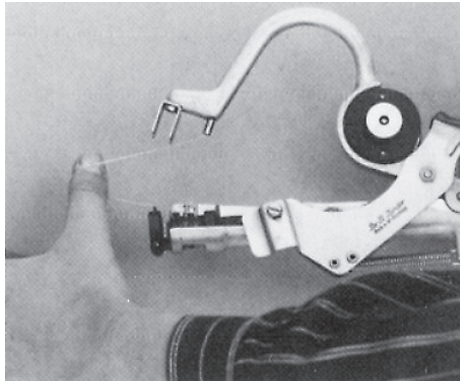

6. Use a thumb to form a loop in the wire and close the **tool without exerting too much force** until a **slight click** is heard.

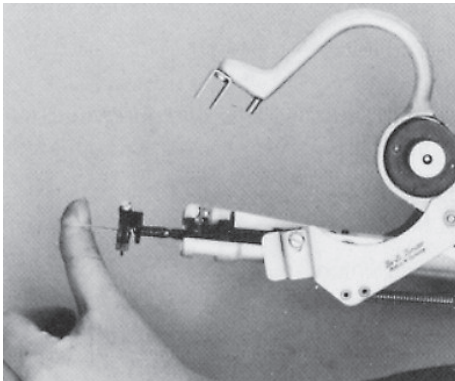

7. Pull the loop out of the head ...

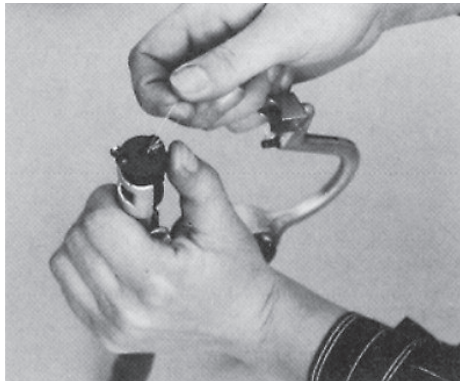

8. ... or remove it in the direction of the press-in device by pressing on the wire retainer.

Minor rectification

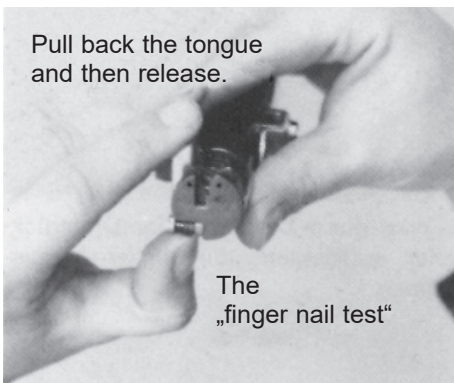
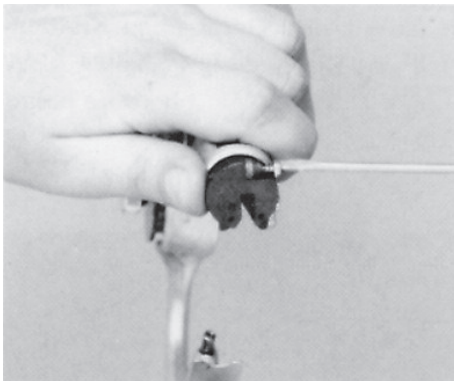
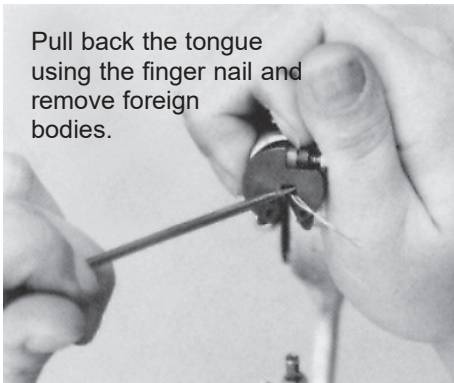

Each new tool is functionally tested and precisely adjusted by us. If defects occur in the course of time, these can be rectified as described below and shown in the illustrations.

The wire no longer twirls properly.

- a) Bits of wire or foreign bodies may be gathered in the head.
 - These must be removed.

Top picture.

- b) The wire loop can be pulled out too easily.
 - Tighten the adjusting screw in the head half a turn, repeat as necessary until the binding again operates properly.

Center picture.

Caution: The spring must not be closed completely by the adjusting screw!

Do the finger nail test.

Bottom picture

- c) The adjusting screw may be bent by striking the stop.

Check that the tongue is lightly spring-loaded.

Carry out the finger nail test.

If the adjusting screw is bent, it must be replaced.

BELI Vine Tying Tool (Spareparts)

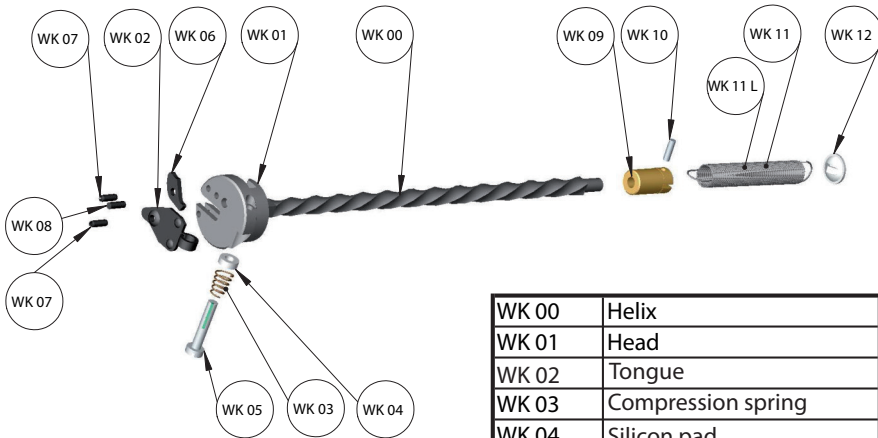

WK 00	Helix
WK 01	Head
WK 02	Tongue
WK 03	Compression spring
WK 04	Silicon pad
WK 05	Adjusting screw
WK 06	Retainer
WK 07	Clamping pin, D 2 x 6
WK 08	Rubber pad pin, D 2 x 6
WK 09	MS piston
WK 10	Dowel pin, D 2 x 6
WK 11	Return spring
WK 11 L	Return spring long
WK 12	Blanking cap

SEIBERT GmbH Gerätebau

Mühlstrasse 19

D-76889 Barbelroth

Telefon 00 49(0) 63 43/21 39

Telefax 00 49(0) 63 43/50 94

Internet:

www.rebenbindegeraet.de

e-mail:

info@rebenbindegeraet.de

G 01	Roundhead screw
G 02	Serrated washer, A3
G 03	Aperture
G 04	Stud, M4 x 5
G 05	MS bush
G 06	Rivet pin, D 4 x 20
G 07	Shaft circlip
G 08	Roller
G 09	Dowel pin, D 3
G 11	Tension spring 7 mm chrome
G 12	Clamping pin, D 3 x 8
G 13	Plastic cover

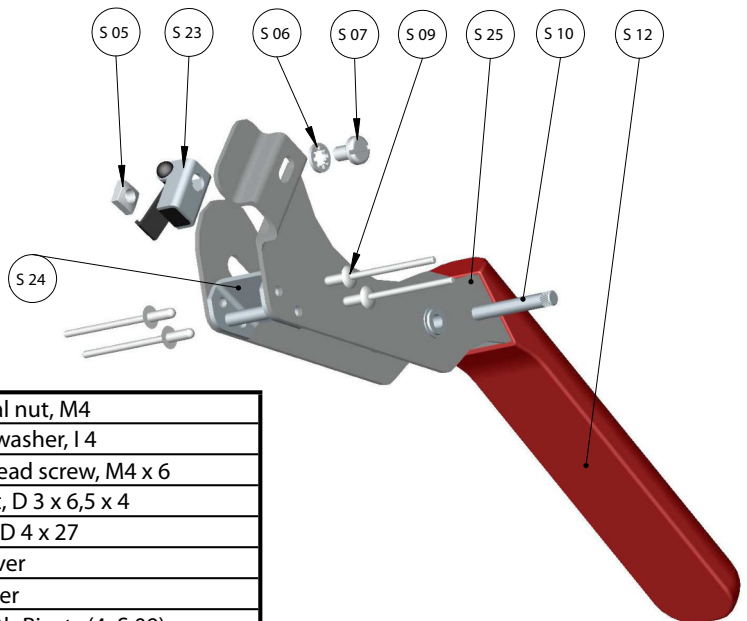
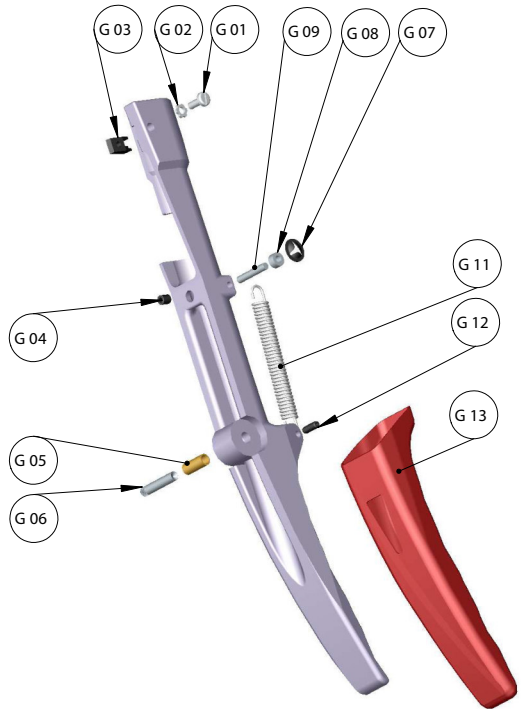

S 05	Hexagonal nut, M4
S 06	Serrated washer, I 4
S 07	Cheese-head screw, M4 x 6
S 09	Blind rivet, D 3 x 6,5 x 4
S 10	Rivet pin, D 4 x 27
S 12	Plastic cover
S 23	Transporter
S 24	Bridge with Rivets (4xS 09)
S 25	Switch grip with plastic cover (S 12)

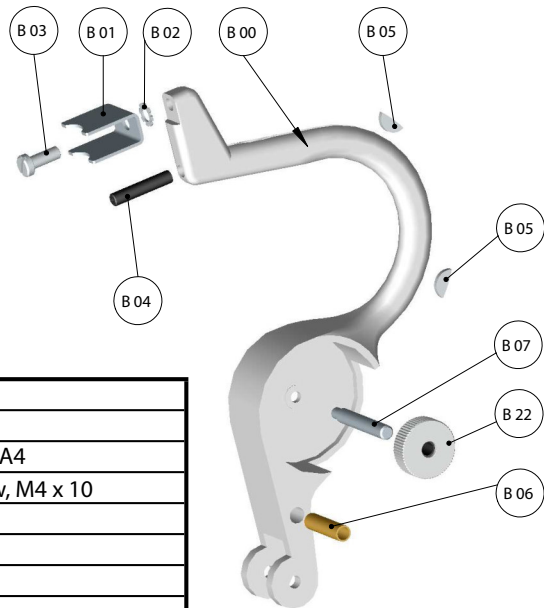

B 00	Clip
B 01	Press-in device
B 02	Serrated washer, A4
B 03	Roundhead screw, M4 x 10
B 04	Nozzle
B 05	Half moon x 2
B 06	MS bush
B 07	Axle
B 22	Spool-brake

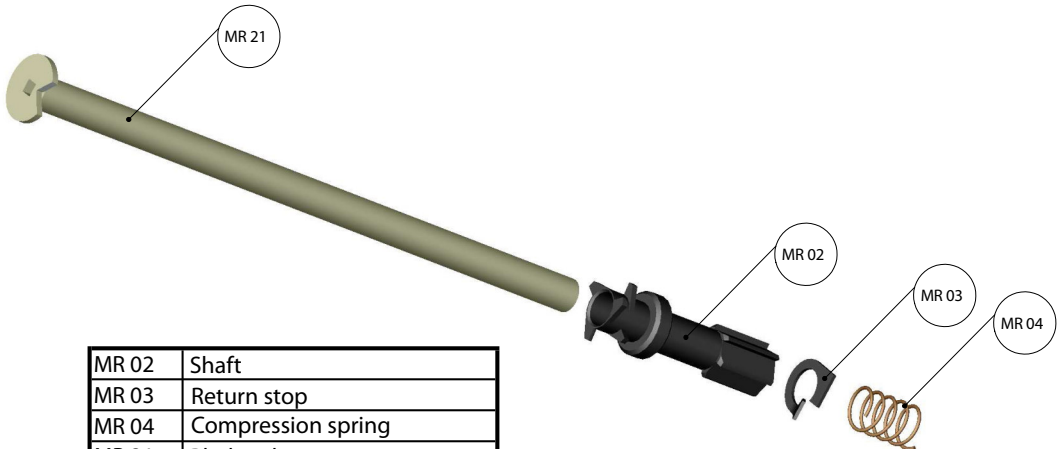

MR 02	Shaft
MR 03	Return stop
MR 04	Compression spring
MR 21	Blade tube

BELI Vine Tying Tool (Accessories)



OE 01 - BELI Special Oil

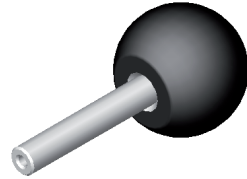

MV - Mounting device for WK 07

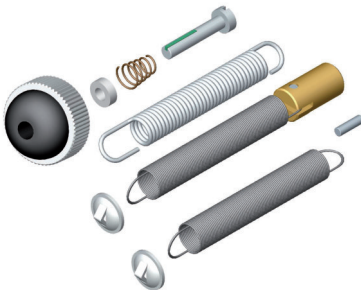

VS 01 L - Wearparts-Set with WK 11 L

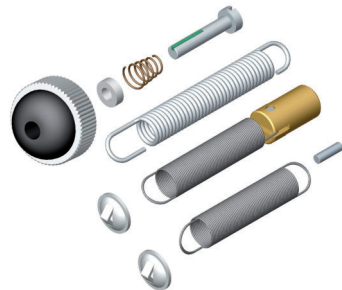

VS 01 - Wearparts-Set with WK 11

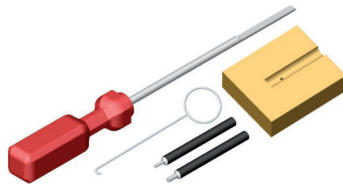

WS 01 - Tool Set

Minor rectification

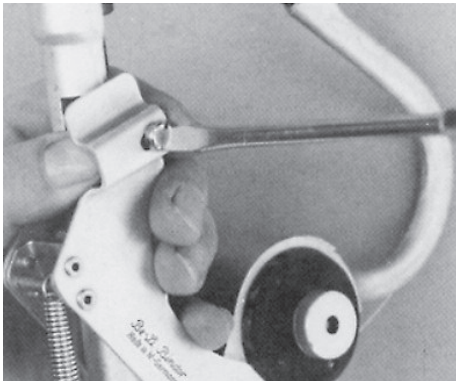
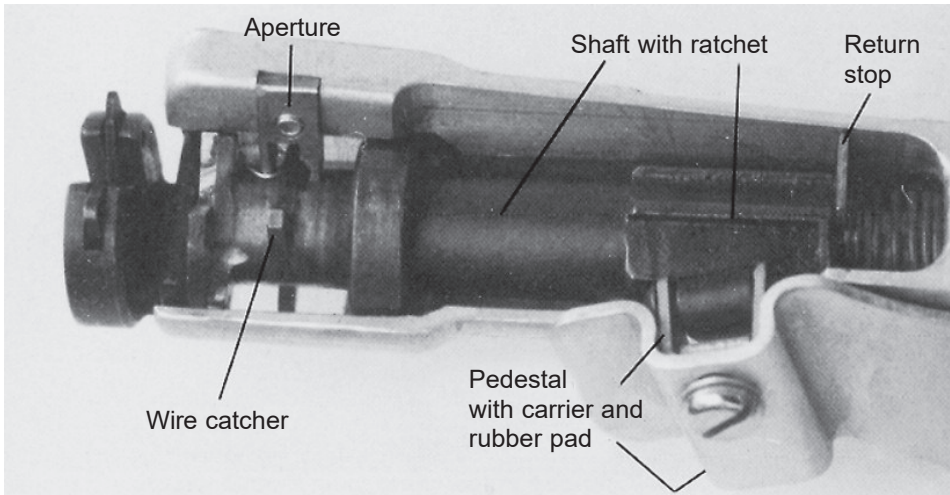

a) The shaft is rotated too far or the ratchet does not engage.

The return stop should always engage in the ratchet with the minimum backlash, max. 1 mm.

This can be adjusted by shifting the pedestal and carrier. To do this slacken the screw, slide the pedestal 1 mm forwards or backwards, retighten the screw and carry out a binding test.

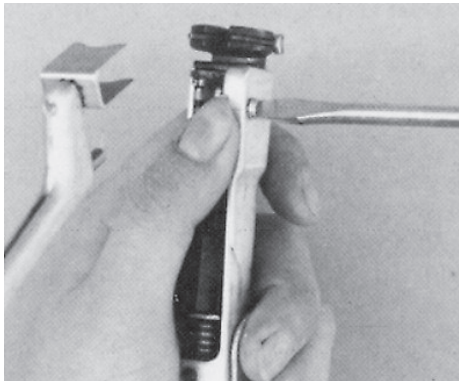

b) The wire slips through between the aperture and shaft.

The aperture must always lie on the shaft.

Slacken the screw, firmly press down the aperture using the thumb and then tighten the screw.

Replacement of springs and rubber pad

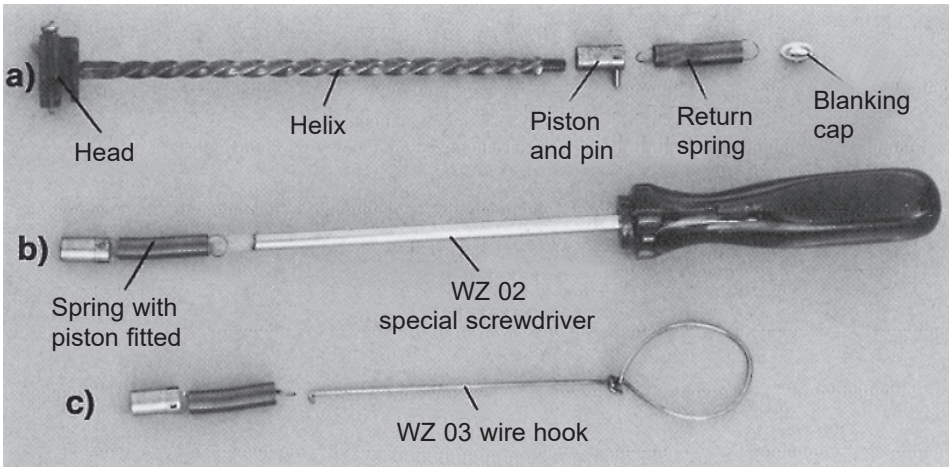

The helix no longer returns on its own.

a) The **return spring** may be broken.

Remove the old spring as follows.

Hold the helix in the pushed-in position, insert the special screwdriver through the opening in the blade tube and unscrew the piston.

Using a 2 mm drift, drive out the pin from the piston far enough to enable the new spring to be pushed in. Push the spring into place and drive in the pin until flush.

Fitting new spring

Insert the special screwdriver through the spring into the piston slot.

Insert the piston with the spring and screwdriver into the opening of the blade tube and rotate clockwise until the piston is securely seated.

Using the steel wire hook, withdraw the eye of the spring approximately 20 mm from the tube and clip the blanking cap in place. Press in the strap of the blanking cap far enough so that the spring cannot hang out. Make sure the spring is not jammed.

Allow the spring to return until the blanking cap lies on the blade tube.

b) The **helix** may be bent.

In this case the helix must be either straightened or replaced. We recommend that the repair be carried out by us.

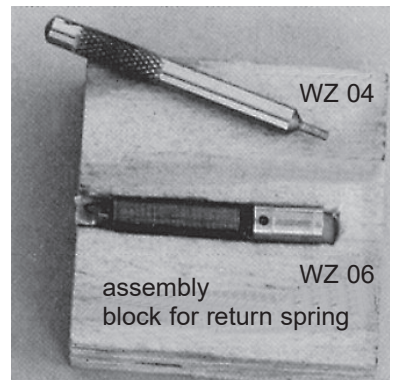

Replacement of springs and rubber pad

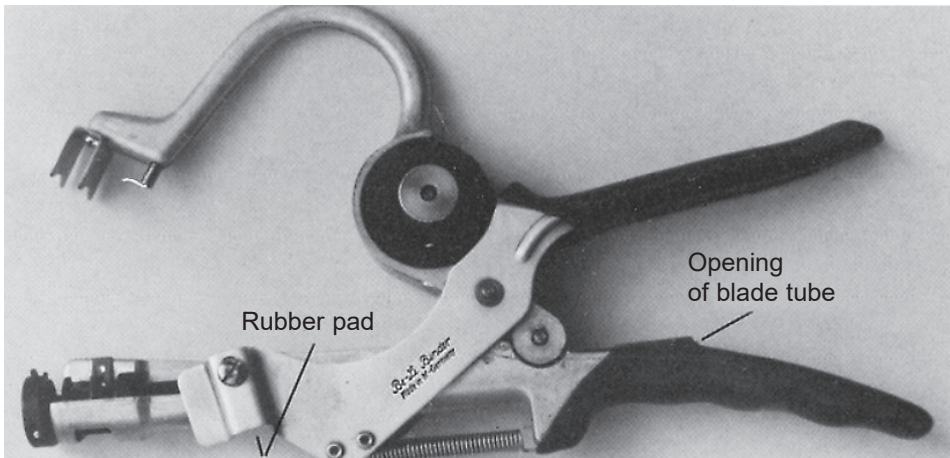

The shaft cannot be rotated further.

The rubber pad in the block may have softened or fallen out due to the use of the incorrect oil or a solvent.

Fitting a new rubber pad.

Clean the pedestal, without removing it, using a nitro solvent or similar substance. Apply contact adhesive (Pattex) to three sides of the rubber pad and the contact points in the pedestal, slide in until flush and press down using pliers.

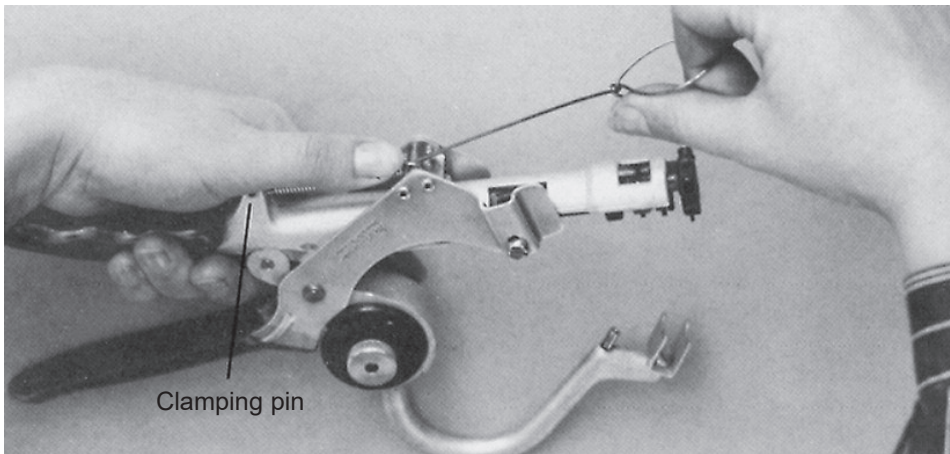

The tension spring has broken.

Remove the bits of the old spring. Using a 3 mm drift, drive back the clamping pin until the slot for the spring is clear. Position a new spring using the elongated eye end and drive in the pin. Using the steel wire hook pull the round eye end over the retaining pin and press in with the thumb without bending.

Care and maintenance

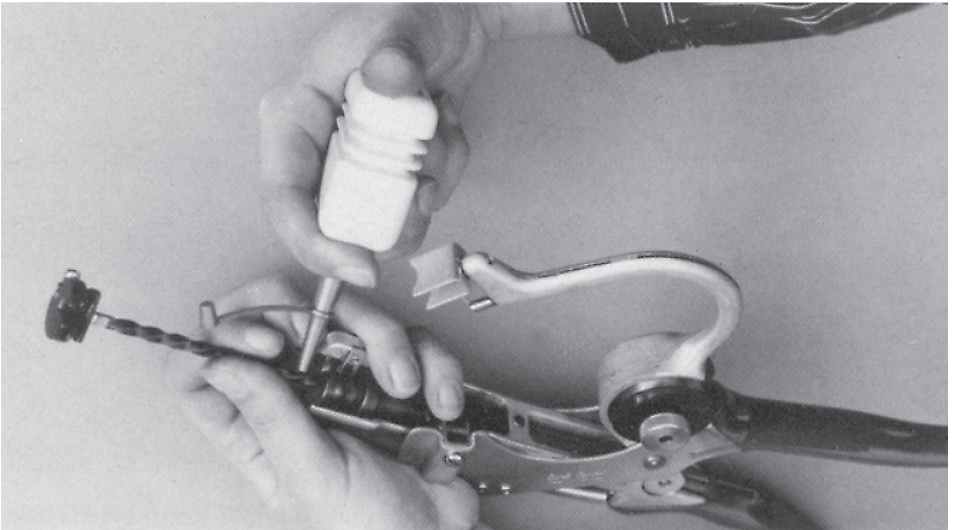

The helix should always be covered with a light film of oil.
Withdraw the helix to oil.

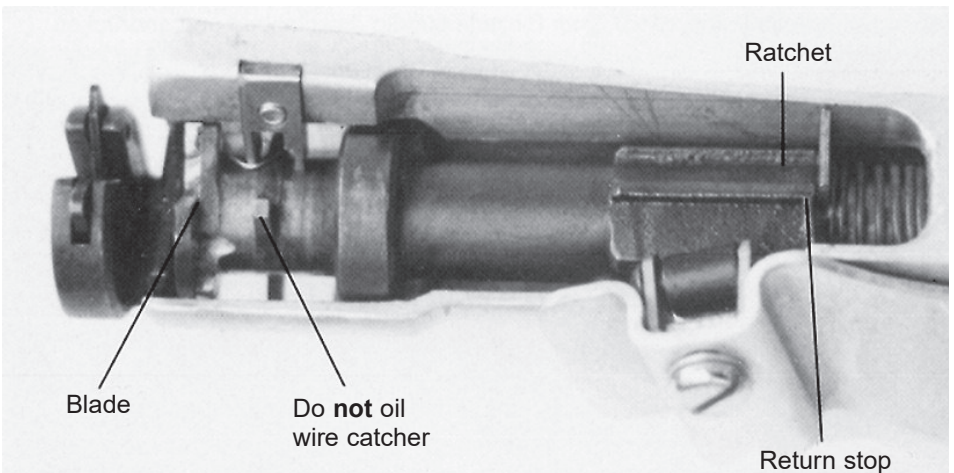

There must always be a light film of oil in the area of the blade and between the return stop and ratchet. Oil these areas as necessary.

The area of the **wire catcher** and the **aperture** must be kept **free of oil**, because otherwise this could cause bits of wire to adhere.

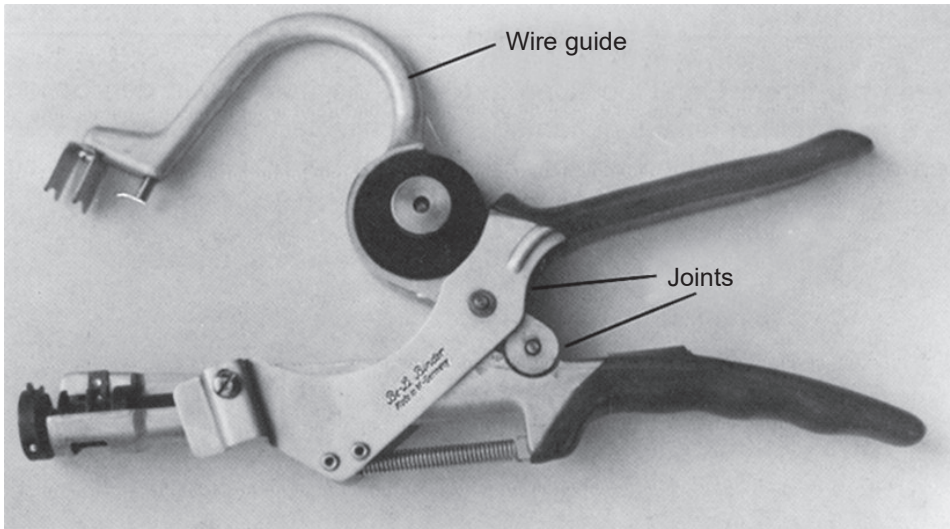

Lightly oil the wire guide slot daily (1 drop of oil).

Oil the joints once a year.

After the tool has been used, particularly after working in damp weather, leave the unit to dry out unpacked. Oil as necessary.

Use only BELI special oil, available from us.

Recommendation

If damage occurs to your tool which is beyond the scope of pages 6 to 9 or if wear parts require replacement, we recommend that you return the tool to us for repair.

Because all parts can be replaced, almost any repair is economical.

Warranty

We provide a one year warranty covering all material and manufacturing defects for every new tool.

The warranty does not cover spring breakage, damage due to incorrect usage or the application of force or normal wear.

We do not consider claims other than repairs.

In the event of a warranty claim, return the tool to us with proof of date of purchase.

Spare parts for minor rectification

Parts for head	WK 02	Tongue
	WK 03	Compression spring
	WK 04	Silicon pad
	WK 05	Adjusting screw, special M 3 x 16
	WK 06	Retainer
	WK 07	Pin, dia. 2 x 6 (x 2)
	WK 08	Rubber pad for head, dia. 2 x 6
	WK 22	Piston with return spring fitted (WK 09 - WK 11)
WK 11 - 12	Return spring and blanking cap	
G 01	Aperture	
G 11	Tension spring, 7 mm	
S 02	Rubber pad for Transporter	
B 22	Spool brake (B 08 + B 09)	

Tools for minor rectification

WS 01	Tool set (WZ 02 - WZ 06)
WZ 02	Special screwdriver
WZ 03	Steel wire hook
WZ 04	Drift, 2 mm dia.
WZ 05	Drift, 3 mm dia.
WZ 06	Assembly block
OE 01	BELI special oil, 100 ml
VS 01	Set of wear parts with WK 11
VS 01 L	Set of wear parts with WK 11 L
MV	Mounting device for WK 07

SEIBERT Gerätebau GmbH
Mühlstrasse 19 · D-76889 Barbelroth
Tel. 00 49 (0) 63 43/21 39 or 6 14 54 · Fax 50 94
Internet: www.rebenbindegeraet.de
e-mail: info@rebenbindegeraet.de
